

# Hi-MO 6

Explorer

## LR5-54HTB 415~435M

- Suitable for Distribution Market
- Pure black for extreme elegance
- Better energy generation performance
- High-quality module guarantees long-term reliability



25-year Warranty for  
Materials and Processing



25-year Warranty for Extra  
Linear Power Output

### Complete System and Product Certifications

IEC 61215, IEC 61730, UL 61730

ISO9001:2015: ISO Quality Management System

ISO14001: 2015: ISO Environment Management System

ISO45001: 2018: Occupational Health and Safety

IEC62941: Guideline for module design qualification and type approval

**LONGI**



**22.3%**  
MAX MODULE  
EFFICIENCY

**0~3%**  
POWER  
TOLERANCE

**<1.5%**  
FIRST YEAR  
POWER DEGRADATION

**0.40%**  
YEAR 2-25  
POWER DEGRADATION

## Additional Value

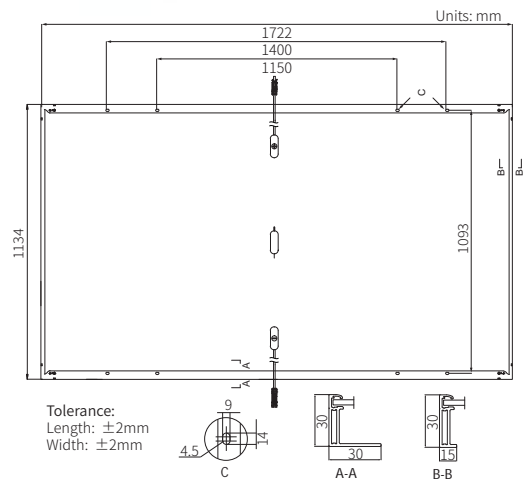
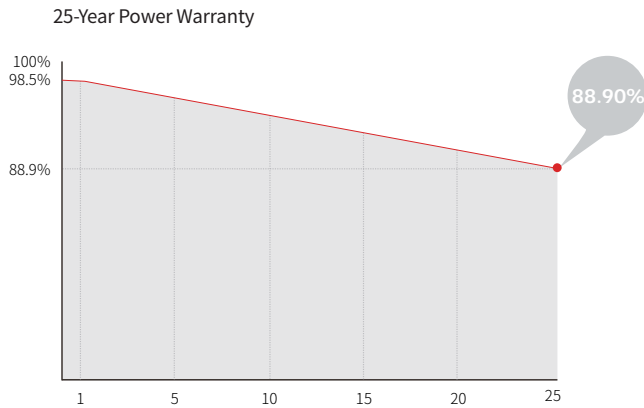

## Mechanical Parameters

Cell Orientation	108 (6×18)
Junction Box	IP68
Output Cable	4mm <sup>2</sup> , ±1200mm length can be customized
Glass	Single glass, 3.2mm coated tempered glass
Frame	Anodized aluminum alloy frame
Weight	20.8kg
Dimension	1722×1134×30mm
Packaging	36pcs per pallet / 216pcs per 20' GP / 936pcs per 40' HC

## Electrical Characteristics

STC: AM1.5 1000W/m<sup>2</sup> 25°C      NOCT: AM1.5 800W/m<sup>2</sup> 20°C 1m/s      Test uncertainty for Pmax: ±3%

Module Type	LR5-54HTB-415M		LR5-54HTB-420M		LR5-54HTB-425M		LR5-54HTB-430M		LR5-54HTB-435M	
	STC	NOCT	STC	NOCT	STC	NOCT	STC	NOCT	STC	NOCT
Maximum Power (Pmax/W)	415	310	420	314	425	318	430	321	435	325
Open Circuit Voltage (Voc/V)	38.83	36.46	39.03	36.65	39.23	36.83	39.43	37.02	39.63	37.21
Short Circuit Current (Isc/A)	13.78	11.13	13.85	11.19	13.93	11.25	14.00	11.31	14.08	11.37
Voltage at Maximum Power (Vmp/V)	32.56	29.71	32.76	29.89	32.96	30.08	33.16	30.26	33.36	30.44
Current at Maximum Power (Imp/A)	12.75	10.44	12.83	10.50	12.90	10.56	12.97	10.62	13.05	10.68
Module Efficiency(%)	21.3		21.5		21.8		22.0		22.3	

## Operating Parameters

Operational Temperature	-40°C ~ +85°C
Power Output Tolerance	0 ~ 3%
Voc and Isc Tolerance	±3%
Maximum System Voltage	DC1500V (IEC/UL)
Maximum Series Fuse Rating	25A
Nominal Operating Cell Temperature	45±2°C
Protection Class	Class II
Fire Rating	UL type 1 or 2 IEC Class C

## Mechanical Loading

Front Side Maximum Static Loading	5400Pa
Rear Side Maximum Static Loading	2400Pa
Hailstone Test	25mm Hailstone at the speed of 23m/s

## Temperature Ratings (STC)

Temperature Coefficient of Isc	+0.050%/°C
Temperature Coefficient of Voc	-0.230%/°C
Temperature Coefficient of Pmax	-0.290%/°C